

## CompactLogix Controllers Specifications

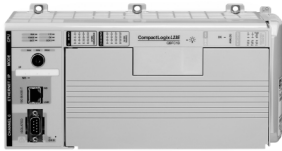

### 1769 Packaged Controller Catalog Numbers

1769-L23-QBFC1B, 1769-L23E-QB1B, 1769-L23E-QBFC1B

### 1769 Modular Controller Catalog Numbers

1769-L31, 1769-L32C, 1769-L35CR, 1769-L32E, 1769-L35E

### 1768 Controller Catalog Numbers

1768-L43, 1768-L43S, 1768-L45, 1768-L45S

### CompactFlash Card Catalog Numbers

1784-CF64, 1784-CF128

Topic	Page
1769 Packaged CompactLogix Controllers with Embedded I/O	3
1769 Modular CompactLogix Controllers	15
1768 CompactLogix Controllers	20
Controller Memory Use	27
Controller Compatibility	28
Controller Connections	32
Determine Total Connection Use	34
CompactLogix Controller Accessories	35

## Important User Information

Solid state equipment has operational characteristics differing from those of electromechanical equipment. Safety Guidelines for the Application, Installation and Maintenance of Solid State Controls (publication [SGI-1.1](#) available from your local Rockwell Automation sales office or online at <http://www.rockwellautomation.com/literature/>) describes some important differences between solid state equipment and hard-wired electromechanical devices. Because of this difference, and also because of the wide variety of uses for solid state equipment, all persons responsible for applying this equipment must satisfy themselves that each intended application of this equipment is acceptable.

In no event will Rockwell Automation, Inc. be responsible or liable for indirect or consequential damages resulting from the use or application of this equipment.

The examples and diagrams in this manual are included solely for illustrative purposes. Because of the many variables and requirements associated with any particular installation, Rockwell Automation, Inc. cannot assume responsibility or liability for actual use based on the examples and diagrams.

No patent liability is assumed by Rockwell Automation, Inc. with respect to use of information, circuits, equipment, or software described in this manual.

Reproduction of the contents of this manual, in whole or in part, without written permission of Rockwell Automation, Inc., is prohibited.

Throughout this manual, when necessary, we use notes to make you aware of safety considerations.

---

### WARNING



Identifies information about practices or circumstances that can cause an explosion in a hazardous environment, which may lead to personal injury or death, property damage, or economic loss.

---

### IMPORTANT

Identifies information that is critical for successful application and understanding of the product.

---

### ATTENTION



Identifies information about practices or circumstances that can lead to personal injury or death, property damage, or economic loss. Attentions help you identify a hazard, avoid a hazard, and recognize the consequence

---

### SHOCK HAZARD



Labels may be on or inside the equipment, for example, a drive or motor, to alert people that dangerous voltage may be present.

---

### BURN HAZARD



Labels may be on or inside the equipment, for example, a drive or motor, to alert people that surfaces may reach dangerous temperatures.

---

Rockwell Automation, Rockwell Software, Allen-Bradley, TechConnect, CompactLogix, SLC, ControlLogix, Compact I/O, POINT I/O, CompactBlock I/O, FLEX I/O, FLEX Ex, ArmorBlock, ArmorPoint, ArmorBlock MaXum, PanelView Plus, PanelView e, InView, GuardLogix, SoftLogix, PowerFlex, DriveLogix, PLC-5, PLC-3, PLC-2, MicroLogix, SCANport, RSLinx 5000, RSLinx, and RSLinx Enterprise are trademarks of Rockwell Automation, Inc.

Trademarks not belonging to Rockwell Automation are property of their respective companies.

## Environmental Specifications - 1768 and 1769 Controllers

Attribute	1769-L23-QBFC1B, 1769-L23E-QB1B, 1769-L23E-QBFC1B	1769-L31, 1769-L32C, 1769-L35CR, 1769-L32E, 1769-L35E, 1768-L43, 1768-L43S, 1768-L45, 1768-L45S
Temperature, operating IEC 60068-2-1 (Test Ad, Operating Cold), IEC 60068-2-2 (Test Bd, Operating Dry Heat), IEC 60068-2-14 (Test Nb, Operating Thermal Shock)	0...60 °C (32...140 °F)	
Temperature, storage IEC 60068-2-1 (Test Ab, Unpackaged Nonoperating Cold), IEC 60068-2-2 (Test Bb, Unpackaged Nonoperating Dry Heat), IEC 60068-2-14 (Test Na, Unpackaged Nonoperating Thermal Shock)	-40...85 °C (-40...185 °F)	
Relative humidity IEC 60068-2-30 (Test Db, Unpackaged Nonoperating Damp Heat)	5...95% noncondensing	
Vibration IEC 60068-2-6 (Test Fc, Operating)	2 g @ 10...500 Hz	5 g @ 10...500 Hz
Shock, operating IEC 60068-2-27 (Test Ea, Unpackaged Shock)	30 g	
Shock, nonoperating IEC 60068-2-27 (Test Ea, Unpackaged Shock)	50 g	

## 1769 Packaged CompactLogix Controllers with Embedded I/O

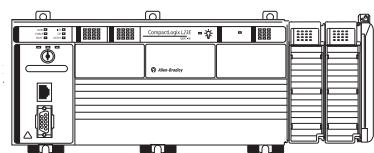

The 1769-L23x controller comes with:

- a built-in power supply.
- either two serial ports or one serial and one EtherNet/IP port.
- a combination of embedded digital, analog, and high-speed counter I/O.
- a 1769-ECR right-end cap.

## Features - 1769 Packaged CompactLogix Controllers

Characteristic	1769-L23-QBFC1B	1769-L23E-QB1B	1769-L23E-QBFC1B
Available user memory	512 KB	512 KB	512 KB
CompactFlash card	None	None	None
Communication ports	2 RS-232 ports (isolated DF1 or ASCII; nonisolated DF1 only)	1 EtherNet/IP port 1 RS-232 serial port (DF1 or ASCII)	1 EtherNet/IP port 1 RS-232 serial port (DF1 or ASCII)
Embedded I/O	<ul style="list-style-type: none"> <li>• 16 DC inputs</li> <li>• 16 DC outputs</li> <li>• 4 analog inputs</li> <li>• 2 analog outputs</li> <li>• 4 high-speed counters</li> </ul>	<ul style="list-style-type: none"> <li>• 16 DC inputs</li> <li>• 16 DC outputs</li> </ul>	<ul style="list-style-type: none"> <li>• 16 DC inputs</li> <li>• 16 DC outputs</li> <li>• 4 analog inputs</li> <li>• 2 analog outputs</li> <li>• 4 high-speed counters</li> </ul>
Module expansion capacity	Up to two additional 1769 modules	Up to three additional 1769 modules	Up to two additional 1769 modules
Embedded power supply	24V DC	24V DC	24V DC

You can add up to two additional 1769 modules to the right of the controller package. The modules you can add depend on their current draw. Each packaged controller has the following amount of 5V DC bus current.

**1769-L23x Available DC Current**

<b>Controller</b>	<b>Available 5V DC Current</b>
1769-L23E-QB1B	1000 mA
1769-L23E-QBFC1B	450 mA
1769-L23-QBFC1B	800 mA

**1769-L23x Local I/O Performance**

The requested packet interval (RPI) defines the frequency at which the controller sends and receives all I/O data on the backplane. The default RPI is 5 ms. The combination of embedded I/O in the packaged controllers determines the fastest RPI you can configure.

<b>Controller</b>	<b>Available 5V DC Current</b>
1769-L23E-QB1B	<ul style="list-style-type: none"> <li>• 1...4 modules can be scanned in 1.0 ms</li> </ul>
1769-L23E-QBFC1B	<ul style="list-style-type: none"> <li>• 1...4 modules can be scanned in 1.5 ms</li> </ul>
1769-L23-QBFC1B	<ul style="list-style-type: none"> <li>• 5...6 modules can be scanned in 2.0 ms</li> </ul>

You can always select an RPI that is slower than listed above. These considerations show how fast modules can be scanned—not how fast an application can use the data. The RPI is asynchronous to the program scan. Other factors, such as program execution duration, affect I/O throughput.

**Technical Specifications - 1769 Packaged CompactLogix Controllers**

<b>Attribute</b>	<b>1769-L23E-QB1B</b>	<b>1769-L23E-QBFC1B</b>	<b>1769-L23-QBFC1B</b>
User memory	512 KB	512 KB	512 KB
Optional flash memory	None		
Number of expansion I/O modules, max	2 (limited by current draw of module)	3 (limited by current draw of module)	2 (limited by current draw of module)
Replacement battery	1769-BA		
Current draw @ 5V DC	1000 mA	450 mA	800 mA
Current draw @ 24V DC	700 mA	500 mA	600 mA
Power dissipation	7.01 W	13.58 W	10.73 W
Isolation voltage	30V (continuous), basic insulation type Type tested at 710V DC for 60 s; RS232 to system backplane, Ethernet to system backplane, and RS232 to Ethernet		30V (continuous), basic insulation type Type tested at 710V DC for 60 s; RS232 channel 0 to system backplane, no isolation between RS232 channel 1 and system

### Technical Specifications - 1769 Packaged CompactLogix Controllers

Attribute	1769-L23E-QB1B	1769-L23E-QBFC1B	1769-L23-QBFC1B
Serial communication ports	CH0 - RS-232 DF1, DH-485, ASCII Fully isolated 38.4 Kbps max		CH0 - RS-232 DF1, DH-485, ASCII Fully isolated 38.4 Kbps max  CH1 - RS-232 DF1, DH-485 Nonisolated 38.4 Kbps max
Serial cables	1756-CP3 or 1747-CP3, right angle connector to controller, straight to serial port, 3 m (9.84 ft)		
Weight, approx.	0.91 kg (2 lb)	1.22 kg (2.7 lb)	1.22 kg (2.7 lb)
Slot width	1		
Module location	DIN rail or panel mount		
Mounting screw torque	1.1...1.8 N•m (10...16 lb•in) - use M4 or #8 screws		
Power supply	1769-PA2, 1769-PB2, 1769-PA4, 1769-PB4		
Wire category <sup>(1)</sup>	2 - on signal ports 2 - on power ports 2 - on communication ports		
Wire size, Ethernet	RJ45 connector according to IEC 60603-7, 2 or 4 pair Category 5e minimum cable according to TIA 568-B.1 or Category 5 cable according to ISO/IEC 24702		—
Wire size, DC power	0.25... 2.5 mm <sup>2</sup> (22...14 AWG) solid or stranded copper wire rated at 75 °C (167 °F) or greater, 1.2 mm (3/64 in.) insulation max		
Wire size, discrete I/O connections	0.5... 0.8 mm <sup>2</sup> (20...18 AWG) solid or stranded copper wire rated at 75 °C (167 °F) or greater, 1.2 mm (3/64 in.) insulation max		
Wire size, embedded analog and high-speed counter connections	0.5... 0.8 mm <sup>2</sup> (20...18 AWG) solid or stranded shielded copper wire rated at 75 °C (167 °F) or greater, 1.2 mm (3/64 in.) insulation max		
North American temperature code	T3C		
Enclosure type rating	None (open-style)		

<sup>(1)</sup> Use this conductor category information for planning conductor routing as described in the system level installation manual. See the Industrial Automation Wiring and Grounding Guidelines, publication [1770-4.1](#).

### Embedded DC Input Specifications

Attribute	1769-L23E-QB1B, 1769-L23E-QBFC1B, 1769-L23-QBFC1B
Inputs	16 (8 points/group)
Voltage category	24V DC sink/source
Operating voltage range	10...30V DC @ 30 °C (86 °F) 10...26.4V DC @ 60 °C (140 °F)
Digital filter, off to on	0 s, 100 μs, 500 μs, 1 ms, 2 ms
Input delay, off to on	100 μs (typical), 300 μs (max)
Digital filter, on to off	0 s, 100 μs, 500 μs, 1 ms, 2 ms
Input delay, on to off	250 μs (typical), 1 ms (max)
Off-state voltage, max	5V DC
Off-state current, max	1.5 mA
On-state current, min	2 mA @ 10V DC
Inrush current, max	250 mA

### Embedded DC Input Specifications

Attribute	1769-L23E-QB1B, 1769-L23E-QBFC1B, 1769-L23-QBFC1B
Input impedance, max	3 k $\Omega$
Cyclic update time	100 $\mu$ s...750 ms
Isolation voltage	75V (continuous), basic insulation type Type tested at 1200V AC for 60 s; inputs to system backplane and input group to input group
IEC input compatibility	Type 3
Isolated groups	Group 1: inputs 0...7 Group 2: inputs 8...15 Isolated groups operate in either sink or source configurations

### Embedded DC Output Specifications

Attribute	1769-L23E-QB1B, 1769-L23E-QBFC1B, 1769-L23-QBFC1B
Outputs	16
Voltage category	24V DC source
Operating voltage range	20.4...26.4V DC
Output delay, off to on	0.1 ms
Output delay, on to off	1.0 ms
Off-state leakage current, max	1.0 mA @ 26.4V DC
On-state current, min	1.0 mA
On-state voltage drop, max	1.0V DC @ 1.0 A
Current per point, max	0.5 A @ 60 °C (140 °F) 1.0 A @ 30 °C (86 °F) Also see the derating graphs
Current per module, max	4.0 A @ 60 °C (140 °F) 8.0 A @ 30 °C (86 °F) Also see the derating graphs on <a href="#">page 7</a>
Surge current per point	2 A for 10 ms per point, repeatable every 2 s
Load current, min	3 mA per point
Isolation voltage	75V (continuous), basic insulation type Type tested at 1200V AC for 60 s; outputs to system backplane
Isolated groups	Group 1: outputs 0...15 (internally connected to common)
Pilot duty rating	0.5 A, 24V DC @ 60 °C (140 °F) 1.0 A, 24V DC @ 30 °C (86 °F)

### Embedded DC Output Temperature Derating

The area within the curves represents the safe operating range for the embedded DC outputs under various conditions of user supplied voltages and ambient temperatures.

#### Embedded DC Outputs Maximum Amperes Per Point versus Temperature

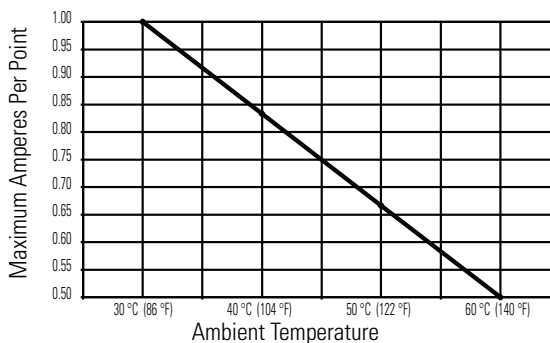

#### Embedded DC Outputs Maximum Amperes Per Module versus Temperature

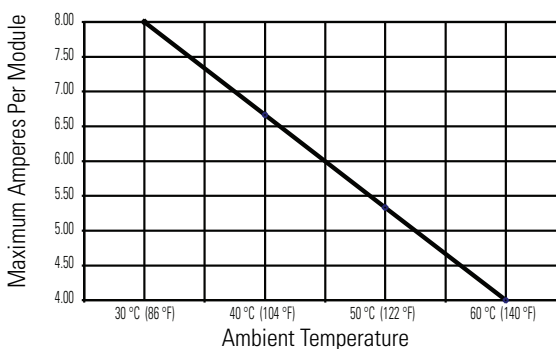

### Embedded Analog Input Specifications

Attribute	1769-L23E-QB1B, 1769-L23E-QBFC1B, 1769-L23-QBFC1B
Inputs	4 differential or single-ended
Input range	0...10.5V 0...21 mA
Resolution	8 bits plus sign (sign is always positive.)
Input impedance	Voltage: 150 k $\Omega$ nom Current: 150 $\Omega$ nom
Converter type	Successive approximation
Response speed per channel	5 ms
Rated working voltage	30V AC/30V DC
Common mode voltage	10V DC max per channel
Common mode rejection	Greater than 60 dB at 60 Hz at 10V between inputs and analog common
Normal mode rejection ratio	None
Accuracy, overall at 25 °C (77 °F) <sup>(1)</sup>	Voltage: $\pm 0.7\%$ full scale Current: $\pm 0.6\%$ full scale

### Embedded Analog Input Specifications

Attribute	1769-L23E-QB1B, 1769-L23E-QBFC1B, 1769-L23-QBFC1B
Accuracy, overall at 0...60 °C (32...140 °F)	Voltage: ±0.9% full scale Current: ±0.8% full scale
Accuracy drift with temperature	Voltage: ±0.006% per °C Current: ±0.006% per °C
Calibration	Not required; accuracy is guaranteed by components
Non-linearity (in percent full scale)	±0.4%
Repeatability	±0.4%
Overload at input terminals, max	Voltage: 20V continuous, 0.1 mA Current: 32 mA continuous, +5V DC
Channel diagnostics	Over-range by bit reporting
Isolation voltage	30V (continuous), basic insulation type Type tested at 500V AC for 60 s; inputs to system backplane and outputs to system backplane

<sup>(1)</sup> Includes offset, gain, non-linearity, and repeatability error terms.

### Embedded Analog Output Specifications

Attribute	1769-L23E-QB1B, 1769-L23E-QBFC1B, 1769-L23-QBFC1B
Outputs	2 single-ended
Output range	0...10.5V 0...21 mA
Converter type	Resistor string
Resolution, max	8 bits plus sign (sign is always positive, Bit 15 = 0.)
Response speed per channel	0.3 ms for rated resistance and rated inductance 3.0 ms for rated capacitance
Current load on voltage output	10 mA max
Resistive load on current output	0...300 Ω (includes wire resistance)
Load range on voltage output	> 1 kΩ at 10V DC
Inductive load, max (current outputs)	0.1 mH
Capacitive load, max (Voltage Outputs)	1 μF
Accuracy, overall at 25 °C (77 °F) <sup>(1)</sup>	Voltage: ±0.5% full scale Current: ±0.5% full scale
Accuracy, overall at 0...60 °C (32...140 °F)	Voltage: ±0.6% full scale Current: ±1.0% full scale
Accuracy drift with temperature	Voltage: ±0.01% full scale per °C Current: ±0.01% full scale per °C
Output ripple range 0...50 kHz (referred to output range)	±0.05%
Non-linearity	±0.4% (in percent full scale)
Repeatability	±0.05% (in percent full scale)



### Embedded Analog Output Specifications

Attribute	1769-L23E-QB1B, 1769-L23E-QBFC1B, 1769-L23-QBFC1B
Output impedance	10 $\Omega$ nom
Open and short-circuit protection	Yes
Short-circuit, max	Current: 40 mA
Open circuit, max	Voltage: 15V
Output response at system powerup and powerdown	+2.0...-1.0V DC spike for less than 6 ms
Isolation voltage	30V (continuous), basic insulation type Type tested at 500V AC for 60 s; inputs to system backplane and outputs to system backplane

<sup>(1)</sup> Includes offset, gain, drift, non-linearity, and repeatability error terms.

### Embedded HSC Input Specifications

Attribute	1769-L23E-QB1B, 1769-L23E-QBFC1B, 1769-L23-QBFC1B
Input frequency, max	250 kHz
Input current, max	15 mA
Input current, min	6.8 mA
Input voltage range	-30...30V DC <sup>(1)</sup>
On-state voltage range	2.6...30V DC
On-state current, min	6.8 mA
Off-state voltage, max	1.0V DC
Off-state current, max	1.5 mA
Off-state leakage current, max	1.5 mA
Input impedance, nom	1950 $\Omega$
Pulse width, min	2.5 $\mu$ s
Phase separation, min	1.084 $\mu$ s
Isolation voltage	75V (continuous), basic insulation type Type tested at 1200V AC for 60 s; inputs to system backplane and input to input

<sup>(1)</sup> See [Maximum Input Voltage - 24V DC Operation](#) temperature derating.

### Embedded HSC Output Specifications

Attribute	1769-L23E-QB1B, 1769-L23E-QBFC1B, 1769-L23-QBFC1B
Output voltage range	5...30V DC
On-state voltage, max	User power - 0.1V DC
On-state output current, max	1A per point 4A per module
On-state output current, min	1 mA
On-state voltage drop, max	0.5V DC
Off-state leakage current, max	5 $\mu$ A
Turn-on time, max	400 $\mu$ s

**Embedded HSC Output Specifications**

Attribute	1769-L23E-QB1B, 1769-L23E-QBFC1B, 1769-L23-QBFC1B
Turn-off time, max	200 $\mu$ s
Reverse polarity protection	30V DC
Isolation voltage	75V (continuous), basic insulation type Type tested at 1200V AC for 60 s; inputs to system backplane and input to input

*Embedded HSC Temperature Derating*

**Maximum Input Voltage - 24V DC Operation**

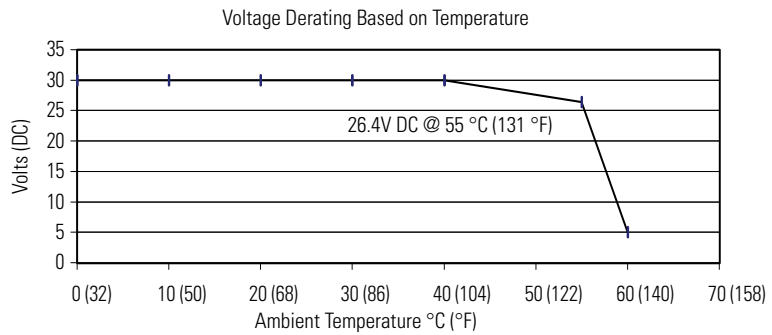

Temperature	Derated Voltage <sup>(1)</sup>
0... 40 °C (32...104 °F)	30V DC
55 °C (131 °F)	26.4V DC
60 °C (140 °F)	5V DC

<sup>(1)</sup> Input voltage derating between 55 °C and 60 °C (131 °F and 140 °F) is achieved by using a dropping resistor.  
 For 24V DC input voltage, use a 2.4 k $\Omega$ , ½ Watt resistor.  
 For input voltages other than 24V DC, use a ½ Watt resistor with value: 125 x (V<sub>in</sub> - 5V).

**Maximum Output Voltage - 24V DC Operation**

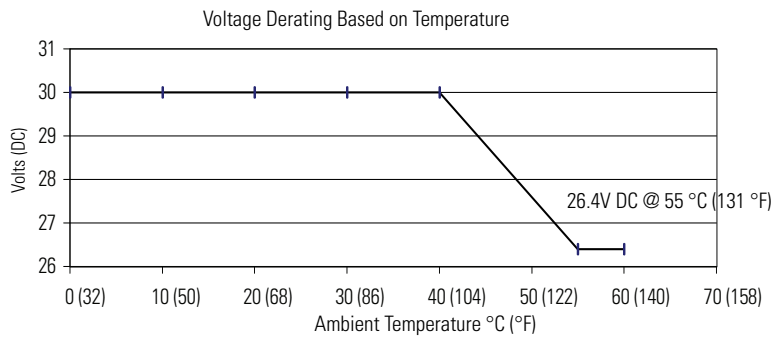

Temperature	Derated Voltage
0...40 °C (32...104 °F)	30V DC
55...60 °C (131...140 °F)	26.4V DC

**Maximum Output Current per Point - 5V DC Operation**

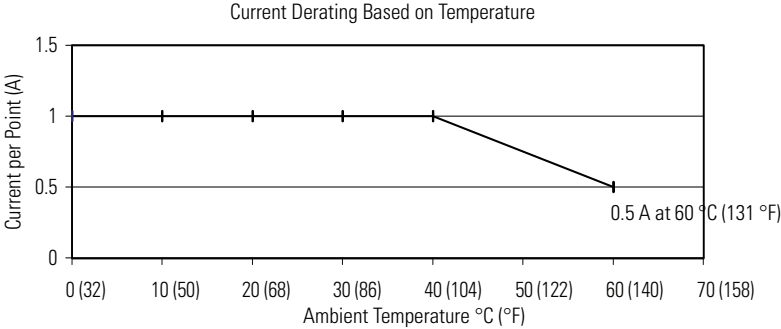

Temperature	Derated Current
0...40 °C (32...104 °F)	1 A
60 °C (140 °F)	0.5 A

**Maximum Output Current per Module - 5V DC Operation**

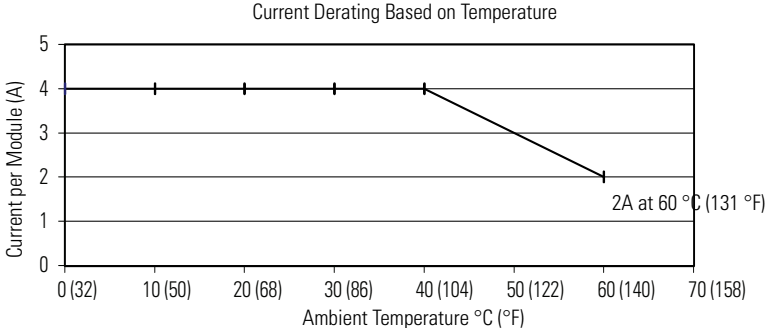

Temperature	Derated Current
0...40 °C (32...104 °F)	4 A
60 °C (140 °F)	2 A

**Maximum Output Current per Point - 24V DC Operation**

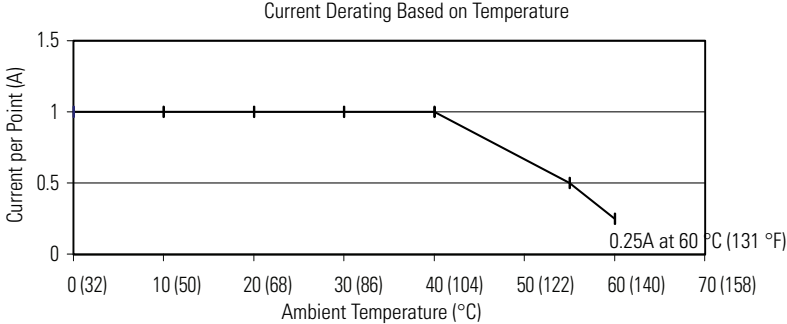

Temperature	Derated Current
0...40 °C (32...104 °F)	1 A
55 °C (131 °F)	0.5 A
60 °C (140 °F)	0.25 A

**Maximum Output Current per Module - 24V DC Operation**

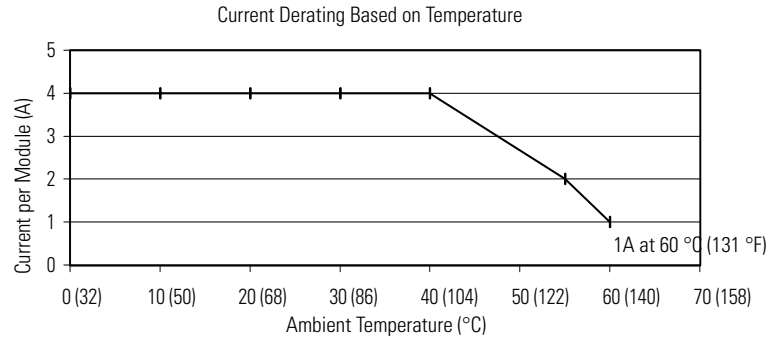

Temperature	Derated Current
0...40 °C (32...104 °F)	4 A
55 °C (131 °F)	2 A
60 °C (140 °F)	1 A

**Embedded Power Supply**

Attribute	1769-L23E-QB1B, 1769-L23E-QBFC1B, 1769-L23-QBFC1B
Input voltage range	19.2...31.2V DC
Input voltage, nom	24V AC
Line requirement, max	50VA at 24V DC
Available 5V DC bus current	1769-L23E-QB1B: 1 A (1000 mA) 1769-L23E-QBFC1B: 450 mA 1769-L23-QBFC1B: 800 mA
Inrush, max	30 A @ 31.2V DC
Line loss ride through	10 ms...10 s
Output bus current capacity	2 A @ 5V DC
0...55 °C (32...131 °F)	0.8 A @ 24V DC
55...60 °C (131...140 °F)	See temperature derating graphs
Minimum load current	0 mA @ 5V DC 0 mA @ 24V DC
Short circuit protection	Front access fuse Replacement part number: Wickmann 19193-6.3A
Overvoltage protection	Yes
Isolation voltage	75V (continuous), basic insulation type Type tested at 1200V AC for 60 s; power to system backplane

**Embedded Power Supply Temperature Derating**

Total Output: 29 W @ 60 °C (140 °F) or Below

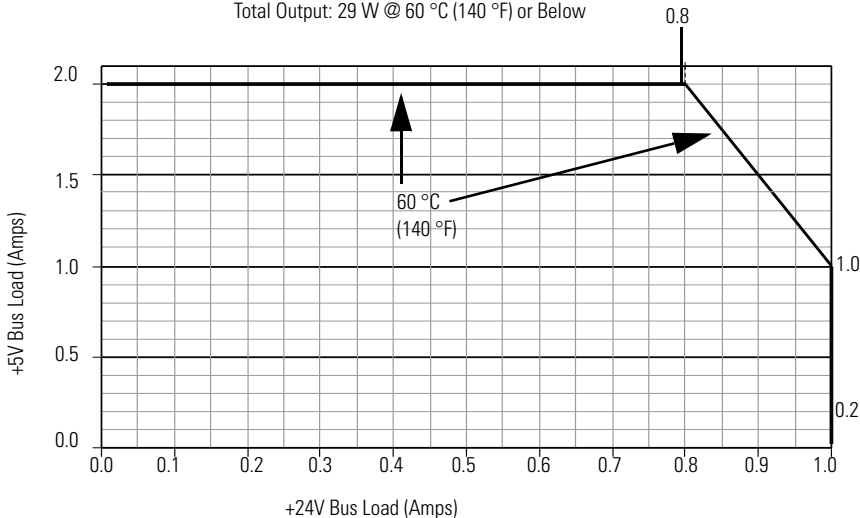

**Certifications - 1769 Packaged CompactLogix Controllers**

Certification <sup>(1)</sup>	1769-L23-QBFC1B, 1769-L23E-QB1B, 1769-L23E-QBFC1B
c-UL-us	UL Listed Industrial Control Equipment, certified for US and Canada. See UL File E65584. UL Listed for Class I, Division 2 Group A,B,C,D Hazardous Locations, certified for U.S. and Canada. See UL File E194810.
CE	European Union 89/336/EEC EMC Directive, compliant with: <ul style="list-style-type: none"> <li>• EN 61326-1; Meas./Control/Lab., Industrial Requirements</li> <li>• EN 61000-6-2; Industrial Immunity</li> <li>• EN 61000-6-4; Industrial Emissions</li> <li>• EN 61131-2; Programmable Controllers (Clause 8, Zone A &amp; B)</li> </ul>
C-Tick	Australian Radiocommunications Act, compliant with: AS/NZS CISPR 11; Industrial Emissions
EtherNet/IP	ODVA conformance tested to EtherNet/IP specifications.

<sup>(1)</sup> When marked. See the Product Certification link at <http://www.ab.com> for Declarations of Conformity, Certificates, and other certification details.

### 1769-L23x Minimum Spacing Requirements

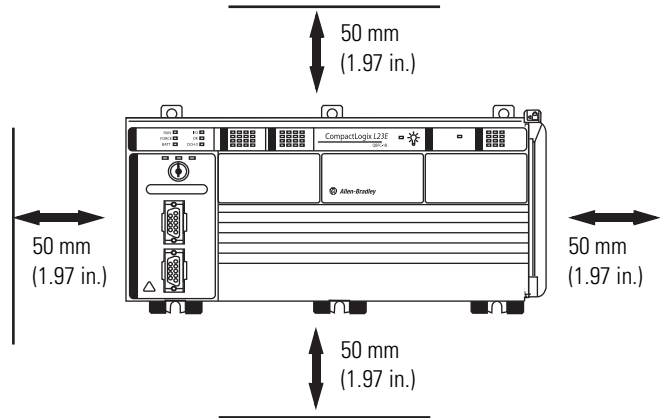

### 1769-L23E-QB1B CompactLogix Dimensions

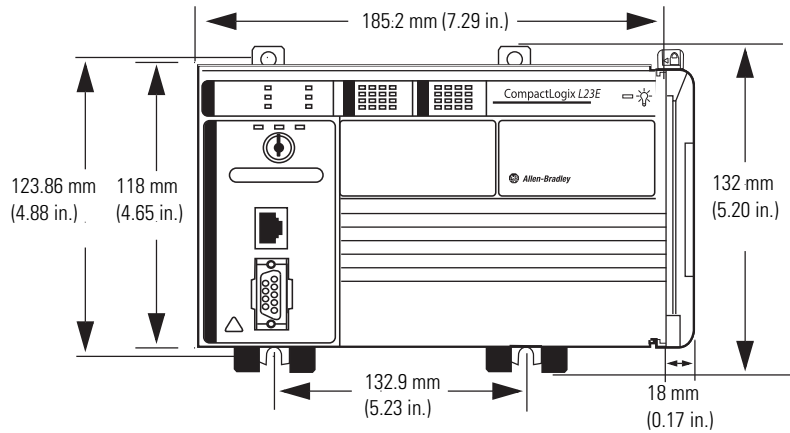

### 1769-L23E-QBFC1B CompactLogix Dimensions

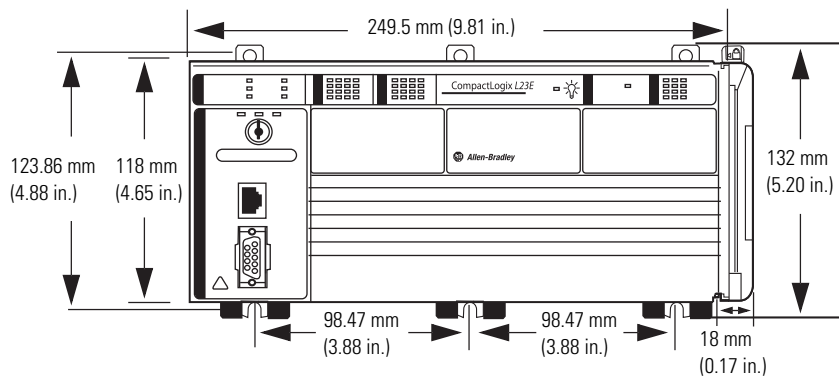

## 1769-L23-QBFC1B CompactLogix Dimensions

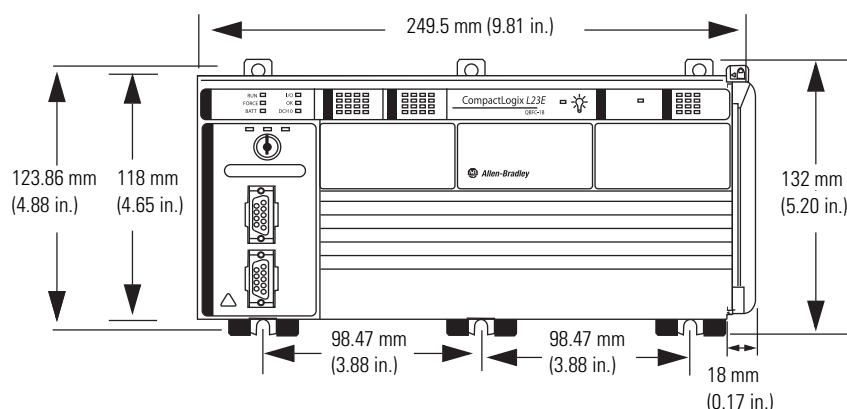

## 1769 Modular CompactLogix Controllers

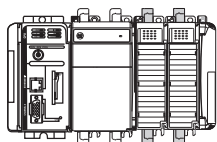

In a 1769-L3x controller system, the 1769 I/O modules can be placed to the left and the right of the power supply. As many as eight modules can be placed on each side of the power supply.

### Features - 1769 Modular CompactLogix Controllers

Characteristic	1769-L31	1769-L32C	1769-L32E	1769-L35CR	1769-L35E
Available user memory	512 KB	750 KB	750 KB	1.5 MB	1.5 MB
CompactFlash card	<ul style="list-style-type: none"> <li>• 1784-CF64</li> <li>• 1784-CF128</li> </ul>	<ul style="list-style-type: none"> <li>• 1784-CF64</li> <li>• 1784-CF128</li> </ul>	<ul style="list-style-type: none"> <li>• 1784-CF64</li> <li>• 1784-CF128</li> </ul>	<ul style="list-style-type: none"> <li>• 1784-CF64</li> <li>• 1784-CF128</li> </ul>	<ul style="list-style-type: none"> <li>• 1784-CF64</li> <li>• 1784-CF128</li> </ul>
Communication ports	2 RS-232 ports (isolated DF1 or ASCII; nonisolated DF1 only)	1 ControlNet port 1 RS-232 serial port (DF1 or ASCII)	1 EtherNet/IP port 1 RS-232 serial port (DF1 or ASCII)	1 ControlNet port 1 RS-232 serial port (DF1 or ASCII)	1 EtherNet/IP port 1 RS-232 serial port (DF1 or ASCII)
Module expansion capacity	16 1769 modules	16 1769 modules	16 1769 modules	30 1769 modules	30 1769 modules
Power supply distance rating	4 modules	4 modules	4 modules	4 modules	4 modules

The CompactLogix controller has a power supply distance rating of four modules. The controller must be the leftmost module in the first bank of the system. The maximum configuration for the first bank of a CompactLogix controller is the controller and three I/O modules to the left of the power supply and eight I/O modules to the right of the power supply.

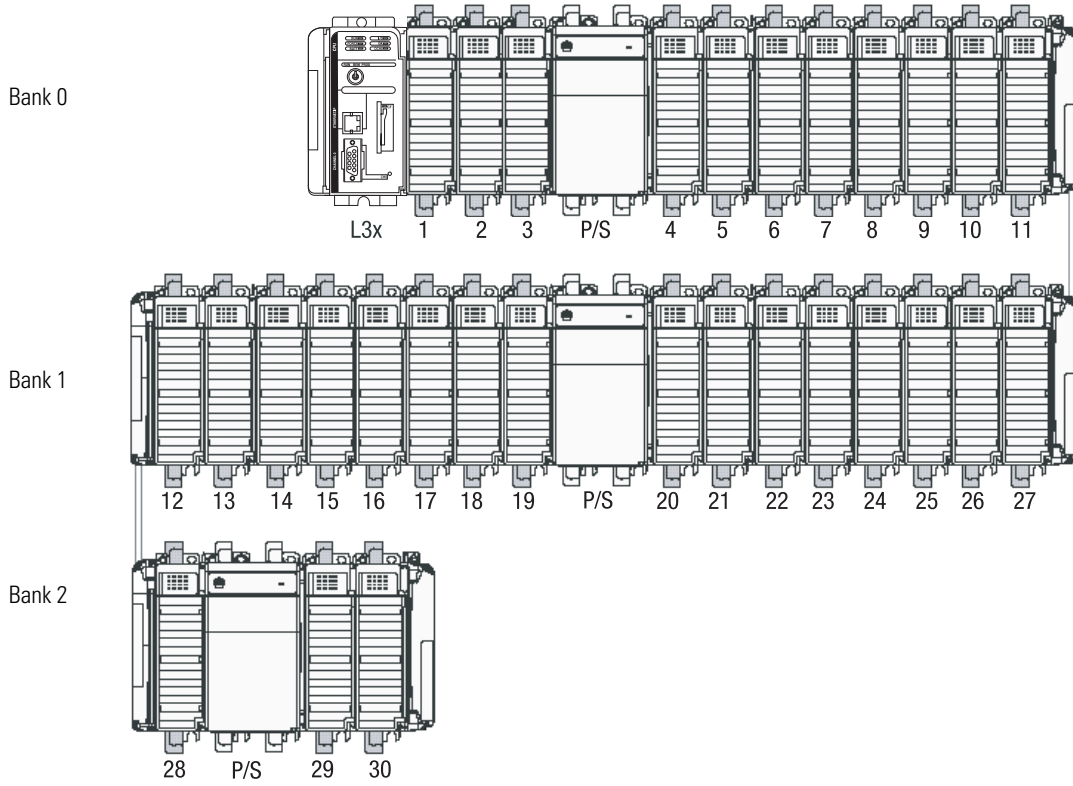



## 1769-L3x Local I/O Performance

There is one requested packet interval (RPI) for the entire 1769 backplane (1...750 ms). As you install modules, the minimum backplane RPI increases. The RPI defines the frequency at which the controller sends and receives all I/O data on the backplane.

Type of Module	Considerations
Digital and analog (any mix)	<ul style="list-style-type: none"> <li>1...4 modules can be scanned in 1 ms</li> <li>5...30 modules can be scanned in 2 ms</li> <li>Some input modules have a fixed 8 ms filter, so selecting a faster RPI has no effect</li> </ul>
Specialty	<ul style="list-style-type: none"> <li>Full-sized 1769-SDN modules add 2 ms per module</li> <li>1769-HSC modules add 1 ms per module</li> <li>Full-sized 1769-ASCII modules add 1 ms per module</li> </ul>

You can always select an RPI that is slower than listed above. These considerations show how fast modules can be scanned—not how fast an application can use the data. The RPI is asynchronous to the program scan. Other factors, such as program execution duration, affect I/O throughput.

### Technical Specifications - 1769 Modular CompactLogix Controllers

Attribute	1769-L31	1769-L32C	1769-L32E	1769-L35CR	1769-L35E
User memory	512 KB	750 KB	750 KB	1.5 MB	1.5 MB
Optional flash memory	1784-CF64 1784-CF128				
Number of I/O modules, max	16	16	16	30	30
Number of I/O banks, max	3				
Number of expansion I/O modules, max	16 1769 modules			30 1769 modules	
Replacement battery	1769-BA				
Current draw @ 5V DC	330 mA	650 mA	660 mA	680 mA	660 mA
Current draw @ 24V DC	40 mA	40 mA	90 mA	40 mA	90 mA
Power dissipation	2.61 W	4.21 W	5.5 W	4.36 W	5.5 W
Isolation voltage	30V (continuous), basic insulation type  Type tested at 710V DC for 60 s; RS232 channel 0 to system  No isolation between RS232 channel 1 and system	30V (continuous), basic insulation type  Type tested at 710V DC for 60 s; RS232 to system, ControlNet to system, RS232 to ControlNet, ControlNet channel A to ControlNet channel B	30V (continuous), basic insulation type  Type tested at 710V DC for 60 s; RS232 to system, Ethernet to system, RS232 to Ethernet	30V (continuous), basic insulation type  Type tested at 710V DC for 60 s; RS232 to system, ControlNet to system, RS232 to ControlNet, ControlNet channel A to ControlNet channel B	30V (continuous), basic insulation type  Type tested at 710V DC for 60 s; RS232 to system, Ethernet to system, RS232 to Ethernet

**Technical Specifications - 1769 Modular CompactLogix Controllers**

Attribute	1769-L31	1769-L32C	1769-L32E	1769-L35CR	1769-L35E
Communication ports	CH0 - RS-232 DF1, DH-485, ASCII Fully isolated 38.4 Kbps max  CH1 - RS-232 DF1, DH-485 Nonisolated 38.4 Kbps max	RS232 Fully isolated 38.4 Kbps max  ControlNet port	RS232 Fully isolated 38.4 Kbps max  EtherNet/IP port 10/100 BASE-T	RS232 Fully isolated 38.4 Kbps max  ControlNet port	RS232 Fully isolated 38.4 Kbps max  EtherNet/IP port 10/100 BASE-T
Serial cables	1756-CP3 or 1747-CP3, right angle connector to controller, straight to serial port, 3 m				
Weight, approx.	0.30 kg (0.66 lb)	0.32 kg (0.70 lb)	0.30 kg (0.66 lb)	0.32 kg (0.70 lb)	0.30 kg (0.66 lb)
Slot width	1				
Module location	DIN rail or panel mount				
Panel-mounting screw torque	1.1...1.8 N•m (10...16 lb•in) - use M4 or #8 screws				
Power supply distance rating	4 modules				
Power supply	1769-PA2, 1769-PB2, 1769-PA4, 1769-PB4				
Wire category <sup>(1)</sup>	2 - on communication ports				
North American temperature code	T5	T4A			
Enclosure type rating	None (open-style)				

<sup>(1)</sup> Use this conductor category information for planning conductor routing as described in the system level installation manual. See the Industrial Automation Wiring and Grounding Guidelines, publication [1770-4.1](#).

**Certifications - 1769 Modular CompactLogix Controllers**

Certification <sup>(1)</sup>	1769-L31	1769-L32C, 1769-L35CR	1769-L32E, 1769-L35E
c-UL-us	UL Listed Industrial Control Equipment, certified for US and Canada. See UL File E65584.  UL Listed for Class I, Division 2 Group A,B,C,D Hazardous Locations, certified for U.S. and Canada. See UL File E194810.		
CE	European Union 89/336/EEC EMC Directive, compliant with: <ul style="list-style-type: none"> <li>EN 61326-1; Meas./Control/Lab., Industrial Requirements</li> <li>EN 61000-6-2; Industrial Immunity</li> <li>EN 61000-6-4; Industrial Emissions</li> <li>EN 61131-2; Programmable Controllers (Clause 8, Zone A &amp; B)</li> </ul>		European Union 89/336/EEC EMC Directive, compliant with: <ul style="list-style-type: none"> <li>EN 61000-6-2; Industrial Immunity</li> <li>EN 61000-6-4; Industrial Emissions</li> </ul>
C-Tick	Australian Radiocommunications Act, compliant with: AS/NZS CISPR 11; Industrial Emissions		
ATEX	—		European Union 94/9/EC ATEX Directive, compliant with: <ul style="list-style-type: none"> <li>EN 60079-15; Potentially Explosive Atmospheres, Protection 'n' (II 3 G Ex nA IIC T4 X)</li> <li>EN 60079-0; General Requirements (Zone 2)</li> </ul>
CI	—	ControlNet International conformance tested to ControlNet specifications	—
EtherNet/IP	—	—	ODVA conformance tested to EtherNet/IP specifications.

<sup>(1)</sup> When marked. See the Product Certification link at <http://www.ab.com> for Declarations of Conformity, Certificates, and other certification details.

### 1769-L3x Minimum Spacing Requirements

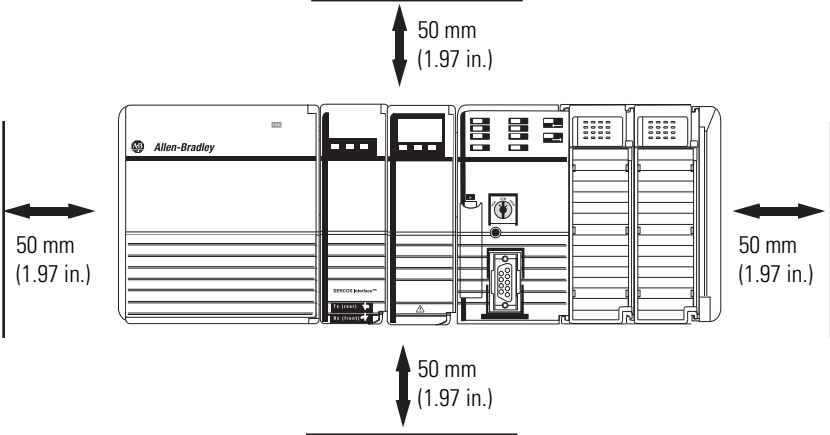

### 1769-L3x CompactLogix Dimensions

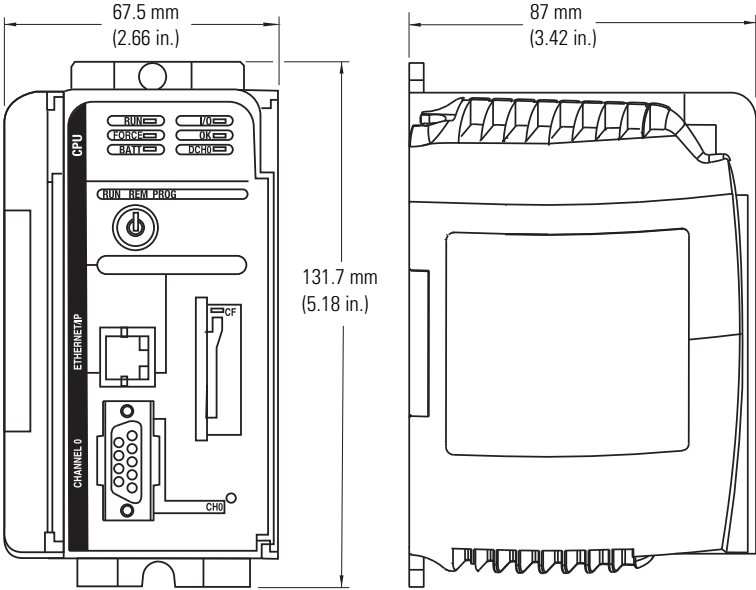

## 1768 CompactLogix Controllers

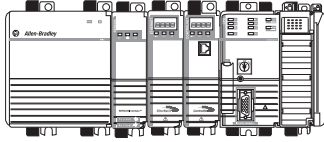

The 1768-L4x controller combines both a 1768 backplane and a 1769 backplane. The 1768 backplane supports the 1768 controller, the 1768 power supply, and a maximum of four 1768 modules. The 1769 backplane supports 1769 modules.

### Features - 1768 CompactLogix Controllers

Characteristic	1768-L43	1768-L43S	1768-L45	1768-L45S
Available user memory	2 MB	2 MB standard 0.5 MB safety	3 MB	3 MB standard 1 MB safety
CompactFlash card	<ul style="list-style-type: none"> <li>1784-CF64</li> <li>1784-CF128</li> </ul>		<ul style="list-style-type: none"> <li>1784-CF64</li> <li>1784-CF128</li> </ul>	
Communication options	<ul style="list-style-type: none"> <li>EtherNet/IP (standard and safety)</li> <li>ControlNet (standard and safety)</li> <li>DeviceNet (standard)</li> </ul>		<ul style="list-style-type: none"> <li>EtherNet/IP (standard and safety)</li> <li>ControlNet (standard and safety)</li> <li>DeviceNet (standard)</li> </ul>	
Serial communication port	1 RS-232 port		1 RS-232 port	
Module expansion capacity	<ul style="list-style-type: none"> <li>2 1768 modules</li> <li>16 1769 modules</li> </ul>		<ul style="list-style-type: none"> <li>4 1768 modules</li> <li>30 1769 modules</li> </ul>	
Power supply distance rating	—		—	
Programming languages	<ul style="list-style-type: none"> <li>Relay ladder</li> <li>Structured text</li> <li>Function block</li> <li>Sequential function chart</li> </ul>	<ul style="list-style-type: none"> <li>Standard task: all languages</li> <li>Safety task: relay ladder, safety application instructions</li> </ul>	<ul style="list-style-type: none"> <li>Relay ladder</li> <li>Structured text</li> <li>Function block</li> <li>Sequential function chart</li> </ul>	<ul style="list-style-type: none"> <li>Standard task: all languages</li> <li>Safety task: relay ladder, safety application instructions</li> </ul>

## Compact GuardLogix Safety System

The Compact GuardLogix controller is a 1768-L4xS CompactLogix controller that provides safety control to achieve SIL 3/PLe according to ISO 13849. A major benefit of this system is that it's still a single project, safety and standard together.

Application	Description
SIL 1, 2, 3	<p>The Compact GuardLogix controller system is type-approved and certified for use in safety applications up to and including SIL 3 according to IEC 61508, and applications up to and including PLe/Cat.4 according to ISO 13849-1. For more information, see:</p> <ul style="list-style-type: none"> <li>GuardLogix Controllers Systems Safety Reference Manual, publication <a href="#">1756-RM093</a>.</li> <li>Compact GuardLogix Controllers User Manual, publication <a href="#">1768-UM002</a>.</li> <li>GuardLogix Safety Application Instruction Set Reference Manual, publication <a href="#">1756-RM095</a>.</li> </ul>

During development, safety and standard have the same rules, multiple programmers, online editing, and forcing are all allowed. Once the project is tested and ready for final validation, you apply the safety application signature and safety-lock the application to set the safety task to a SIL 3 integrity level, which is then enforced by the GuardLogix controller. When safety memory is locked and protected, the safety logic can't be modified and all safety functions operate with SIL 3 integrity. On the standard side of the GuardLogix controller, all functions operate like a regular Logix controller. Thus online editing, forcing, and other activities are all allowed.

With this level of integration, safety memory can be read by standard logic and external devices, like HMIs or other controllers, eliminating the need to condition safety memory for use elsewhere. The result is easy system-wide integration and the ability to display safety status on displays or marquees. Use Guard I/O modules for field device connectivity. For safety interlocking between GuardLogix controllers use Ethernet or ControlNet networks. Multiple GuardLogix controllers can share safety data for zone to zone interlocking, or a single GuardLogix controller can use remote distributed safety I/O between different cells/areas.

### 1768-L4x Placement

In a 1768-L4x controller system, place 1768 modules between the power supply and the controller.

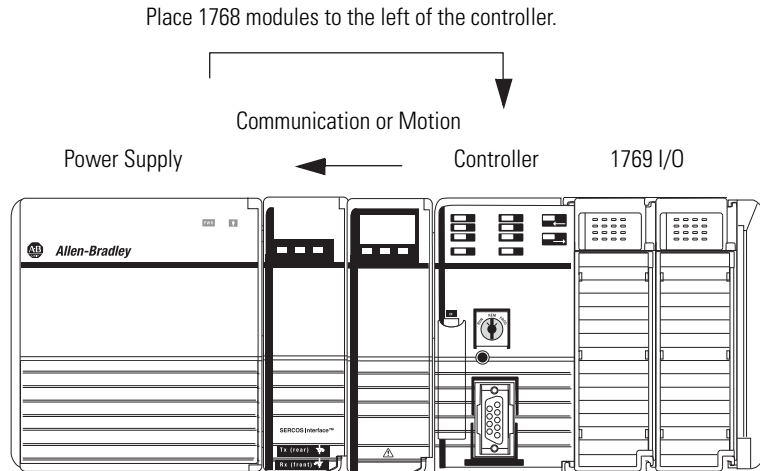

Place 1769 modules to the right of the 1768 backplane.

- As many as eight 1769 modules can be attached to the right of the 1768 system.
- The 1769 I/O connected directly to the 1768 backplane does not need a 1769 power supply.
- Additional 1769 modules must be in additional I/O banks.
- Each additional I/O bank must have its own 1769 power supply.

Place 1769 modules to the right of the controller.

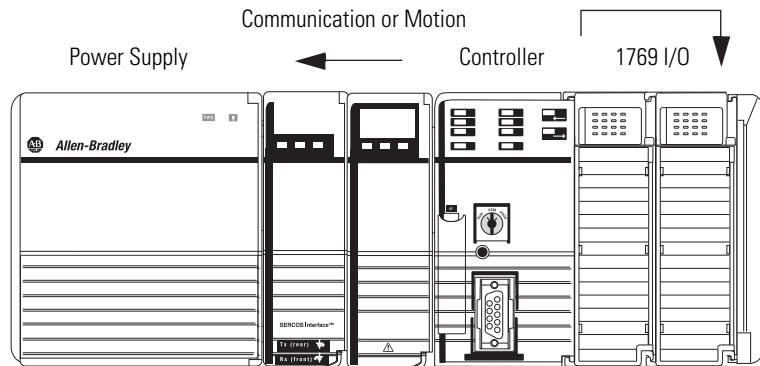

## 1768-L4x Local I/O Performance

Configure an individual RPI for each local 1769 I/O module. Use the default RPI numbers that the software automatically assigns or select faster RPIs as fast as 1 ms I/O update times do not affect overall 1768 bus performance.

- Use faster RPIs for time critical I/O without impacting overall 1769 I/O performance.
- Use Immediate Output (IOT) instructions for further reduction in I/O update times.

### Technical Specifications - 1768 CompactLogix Controllers

Attribute	1768-L43, 1768-L43S	1768-L43, 1768-L43S	1768-L45, 1768-L45S	1768-L45, 1768-L45S
User memory	2 MB	2 MB standard 0.5 MB safety	3 MB	3 MB standard 1 MB safety
Optional flash memory	1784-CF64 1784-CF128			
Number of 1768 modules, max <sup>(1)</sup>	2		4	
Number of 1769 I/O modules, max	16		30	
Number of I/O banks, max	2		3	
Replacement battery	None needed			
Backplane current draw @ 24V DC	1.3 A	1.4 A	2.0 A	2.1 A
1768 current draw @ 5V DC	2.8 A		5.6 A	
1769 current draw @ 5V DC	2.0 A		2.0 A	
Total 1768 and 1769 current draw @ 5V DC	4.8 A		7.6 A	
Power dissipation	6.3 W	7.5 W	8.3 W	9.5 W
Power consumption	31.3 W	33.6 W	48.0 W	50.4 W
Isolation voltage	30V (continuous), functional insulation type Type tested at 500V DC for 60 s; RS-232 to system			
Communication ports	RS-232 Fully isolated, 38.4 Kbps max			
Serial cables	1756-CP3 or 1747-CP3, right angle connector to controller, straight to serial port, 3 m			
Weight, approx.	0.34 kg (11.99 oz)	0.45 kg (15.9 oz)	0.34 kg (11.99 oz)	0.45 kg (15.9 oz)
Dimensions	131.6 x 67.4 x 121.8 mm (5.18 x 2.65 x 4.80 in.)	131.6 x 90 x 121.8 mm (5.18 x 3.55 x 4.80 in.)	131.6 x 67.4 x 121.8 mm (5.18 x 2.65 x 4.80 in.)	131.6 x 90 x 121.8 mm (5.18 x 3.55 x 4.80 in.)
Slot width	1	1.5	1	1.5
Module location	DIN rail or panel mount			
Panel-mounting screw torque	1.16 N•m (10 lb•in) - use M4 or #8 screws			
Power supply distance rating	4 modules			
Power supply	1768-PA3, 1768-PB3			
Wire category <sup>(2)</sup>	2 - on communication ports			
North American temperature code	N/A	T4	N/A	T4
Enclosure type rating	None (open-style)			

<sup>(1)</sup> **Important:** There is a maximum limit of two network modules that can be installed in a system. Network modules include: 1768-ENBT, 1768-CNB, 1768-CNBR, and 1768-EWEB.

<sup>(2)</sup> Use this conductor category information for planning conductor routing as described in the system level installation manual. See the Industrial Automation Wiring and Grounding Guidelines, publication [1770-4.1](#).

**1768-L43 and 1768-L43S Power Dissipation**

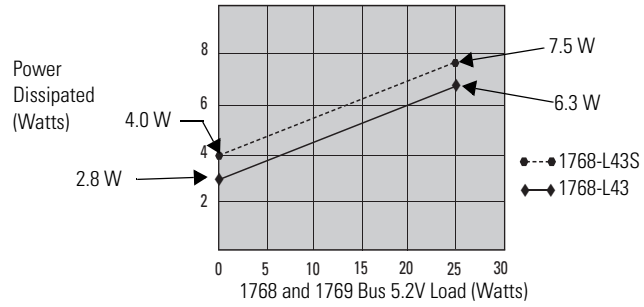

**1768-L45 and 1768-L45S Power Dissipation**

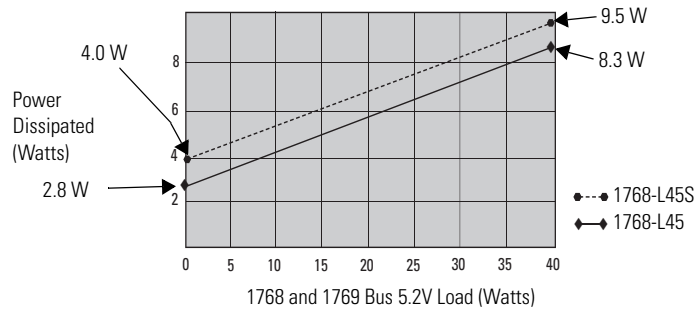

**Certifications - 1768 CompactLogix Controllers**

Certification <sup>(1)</sup>	1768-L43, 1768-L45
c-UL-us	UL Listed Industrial Control Equipment, certified for US and Canada. See UL File E65584. UL Listed for Class I, Division 2 Group A,B,C,D Hazardous Locations, certified for U.S. and Canada. See UL File E194810.
CE	European Union 89/336/EEC EMC Directive, compliant with: <ul style="list-style-type: none"> <li>• EN 61326-1; Meas./Control/Lab., Industrial Requirements</li> <li>• EN 61000-6-2; Industrial Immunity</li> <li>• EN 61000-6-4; Industrial Emissions</li> <li>• EN 61131-2; Programmable Controllers (Clause 8, Zone A &amp; B)</li> </ul>
C-Tick	Australian Radiocommunications Act, compliant with: AS/NZS CISPR 11; Industrial Emissions

<sup>(1)</sup> When marked. See the Product Certification link at <http://www.ab.com> for Declarations of Conformity, Certificates, and other certification details.



**Certifications - 1768 Compact GuardLogix Controllers**

Certification <sup>(1)</sup>	1768-L43S, 1768-L45S
c-UL-us	UL Listed Industrial Control Equipment, certified for US and Canada. See UL File E65584. UL Listed for Class I, Division 2 Group A,B,C,D Hazardous Locations, certified for U.S. and Canada. See UL File E194810.
CE	European Union 2004/108/EC EMC Directive, compliant with: EN 61326-1; Meas./Control/Lab., Industrial Requirements EN 61000-6-2; Industrial Immunity EN 61000-6-4; Industrial Emissions EN 61131-2; Programmable Controllers (Clause 8, Zone A & B)
C-Tick	Australian Radiocommunications Act, compliant with: AS/NZS CISPR 11; Industrial Emissions
Ex	1768-L43S and 1768-L45S only: European Union 94/9/EC ATEX Directive, compliant with: EN 60079-15; Potentially Explosive Atmospheres, Protection 'n' II 3 G Ex nA IIC T4 X EN60079-0; General Requirements
Functional Safety <sup>(2)</sup>	1768-L43S and 1768-L45S only: Certified by TÜV: capable of SIL 1 to 3, according to IEC 61508; and PLe/Cat. 4 according to ISO 13849-1

<sup>(1)</sup> When marked. See the Product Certification link at <http://www.ab.com> for Declarations of Conformity, Certificates, and other certification details.

<sup>(2)</sup> When used with specified software versions.

**1768-L4x Minimum Spacing Requirements**

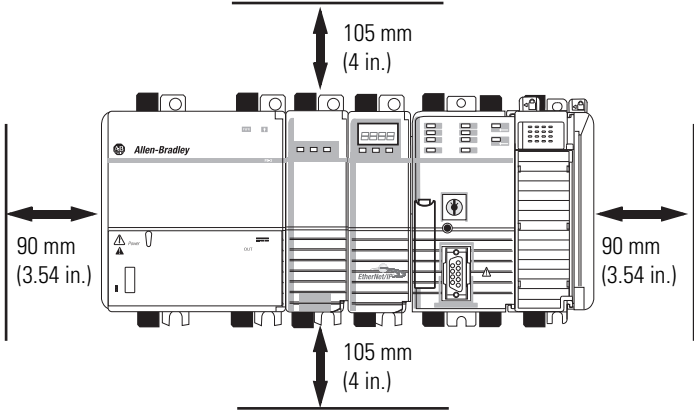

### 1768 Slot Numbering

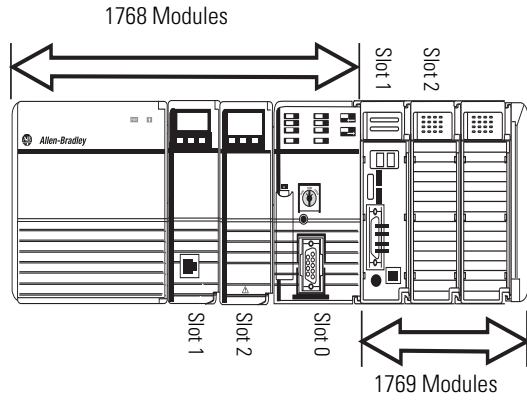

### 1768-L43, 1768-L45 CompactLogix Dimensions

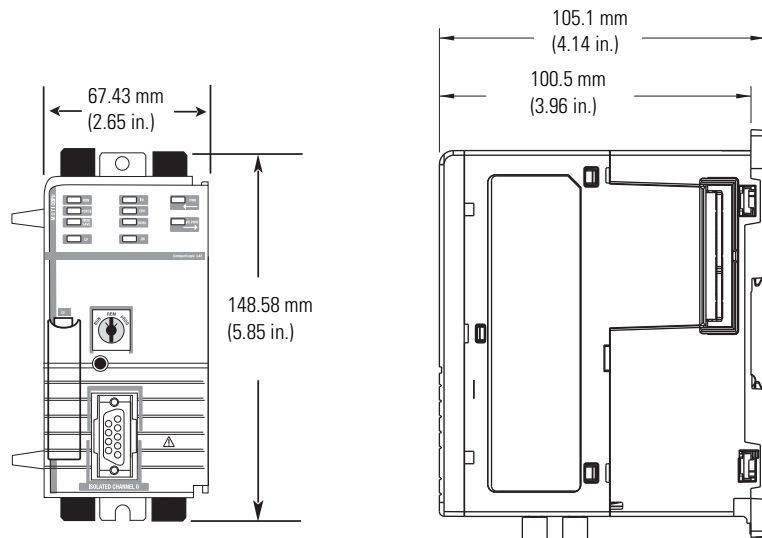

**1768-L43S, 1768-L45S CompactLogix Dimensions**

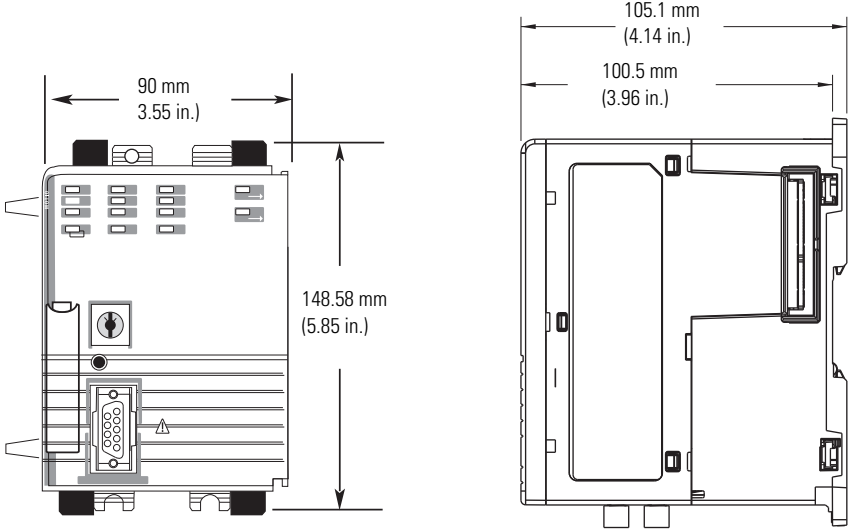

**Controller Memory Use**

These equations provide an estimate of the memory needed for a controller. These numbers are rough estimates.

Controller tasks	_____ * 4000	=	_____ bytes (minimum 1 task)
Digital I/O points	_____ * 400	=	_____ bytes
Analog I/O points	_____ * 2600	=	_____ bytes
DeviceNet modules <sup>(1)</sup>	_____ * 7400	=	_____ bytes
Other communication modules <sup>(2)</sup>	_____ * 2000	=	_____ bytes
Motion axes	_____ * 8000	=	_____ bytes
FactoryTalk alarm instruction	_____ * 1000	=	_____ bytes (per alarm)
FactoryTalk subscriber	_____ * 10000	=	_____ bytes

<sup>(1)</sup> The first DeviceNet module is 7400 bytes. Additional DeviceNet modules are 5800 bytes each.

<sup>(2)</sup> Count all the communication modules in the system, not just those in the local chassis. This includes device connection modules, adapter modules, and ports on PanelView terminals.

Reserve 20...30% of the controller memory for future expansion.

## Controller Compatibility

## Control Distributed I/O Modules

The controller can control these distributed I/O modules.

I/O Modules	1768-ENBT, 1769-L23Ex 1769-L32E, 1769-L35E EtherNet/IP Network <sup>(1)</sup>	1768-CNB, 1768-CNBR 1769-L32X, 1769-L35CR ControlNet Network	1769-SDN DeviceNet Network <sup>(2) (3)</sup>
<b>Chassis-based I/O</b>			
1746 SLC I/O	No	No	No
1756 ControlLogix I/O	Yes	Yes	Yes
1769 Compact I/O	No	No	Yes
1771 Universal I/O	No	No	No
<b>In-Cabinet I/O</b>			
1734 POINT I/O	Yes	Yes	Yes
1734D POINTBlock I/O	Yes	Yes	Yes
1790, 1790D, 1790P CompactBlock LDX I/O	No	No	Yes
1791D, 1791P, 1791R CompactBlock I/O	No	No	Yes
1794 FLEX I/O	Yes	Yes	Yes
1797 FLEX Ex I/O	Yes	Yes	No
<b>On-Machine I/O</b>			
1732 ArmorBlock I/O	Yes	No	Yes
1738 ArmorPoint I/O	Yes	Yes	No
1792D ArmorBlock MaXum I/O	No	No	Yes
1799 Embedded I/O	No	No	Yes

<sup>(1)</sup> A non-EtherNet/IP CompactLogix controller requires a 1761-NET-ENI interface to connect to an EtherNet/IP network. This interface is only a messaging bridge.

<sup>(2)</sup> To control I/O, use a 1769-SDN scanner to connect the controller to the DeviceNet network.

<sup>(3)</sup> The 1769-SDN does not support safety communications to Guard I/O modules on a DeviceNet network.

## Control Safety I/O Modules

The Compact GuardLogix controller can control these safety I/O modules in a safety system.

I/O Modules	EtherNet/IP	ControlNet
1791ES CompactBlock Guard I/O	Yes	No
1734 Point Guard I/O	Yes	No

## Communicate with Display Devices

The controller can communicate with these display devices.

Display Devices	EtherNet/IP Network <sup>(1)</sup>	ControlNet Network	DeviceNet Network <sup>(2)</sup>	RS-232 (DF1) Network	DH-485 Network
<b>Industrial Computers</b>					
Rockwell Automation industrial computers (all) <sup>(3)</sup>	Yes	Yes	Yes	Yes	Yes
<b>Graphic Terminals</b>					
PanelView Plus and PanelView CE terminals	Yes	Yes	Yes	Yes	Yes
PanelView standard terminals	Yes	Yes	Yes	Yes	Yes
PanelView e terminals	No	No	No	No	No
<b>Message Displays</b>					
InView message displays	Yes	Yes	Yes	Yes	Yes

<sup>(1)</sup> A non-EtherNet/IP CompactLogix controller requires a 1761-NET-ENI interface to connect to an EtherNet/IP network. This interface is only a messaging bridge.

<sup>(2)</sup> For DeviceNet access, use either a 1769-SDN scanner (control I/O and send/receive messages) or a 1761-NET-DNI interface (messaging bridge).

<sup>(3)</sup> Includes: Rockwell Automation integrated display rotating media (HDD) and solid state (SSD) computers, Rockwell Automation non-display computers, and Rockwell Automation integrated display computers with keypad.

## Communicate with Other Controllers

The controller can communicate with these programmable controllers.

Controller	EtherNet/IP Network <sup>(1)</sup>	ControlNet Network	DeviceNet Network <sup>(2)</sup>	RS-232 (DF1) Network	DH-485 Network
1756 ControlLogix 1756 GuardLogix	Yes	Yes	Yes	Yes	Yes
1768-L4x CompactLogix	Yes	Yes	Yes	Yes	Yes
1769-L3x CompactLogix	Yes	Yes	Yes	Yes	Yes
1769-L23x CompactLogix	Yes	No	Yes	Yes	Yes
1789 SoftLogix5800	Yes	Yes	Yes	Yes	No
1794 FlexLogix	Yes	Yes	Yes	Yes	Yes
PowerFlex with DriveLogix	Yes	Yes	Yes	Yes	Yes
1785 PLC-5	Yes <sup>(3)</sup> (4)	Yes	Yes <sup>(5)</sup>	Yes	—
1747 SLC	Yes <sup>(6)</sup>	Yes	Yes <sup>(4)</sup>	Yes	Yes
1761 MicroLogix	Yes	No	Yes <sup>(4)</sup>	Yes	Yes
1762 MicroLogix	Yes	No	Yes <sup>(4)</sup>	Yes	Yes
1763 MicroLogix	Yes	No	Yes <sup>(4)</sup>	Yes	Yes
1764 MicroLogix	Yes	No	Yes <sup>(4)</sup>	Yes	Yes
1772 PLC-2	—	—	—	Yes	—
1775 PLC-3	—	—	—	Yes	—
5250 PLC-5/250	—	—	No	Yes	—

<sup>(1)</sup> A non-EtherNet/IP controller requires a 1761-NET-ENI interface to connect to an EtherNet/IP network. This interface is only a messaging bridge.

<sup>(2)</sup> In the CompactLogix system, use either a 1769-SDN scanner (control I/O and send/receive messages) or a 1761-NET-DNI interface (messaging bridge).

<sup>(3)</sup> The Ethernet PLC-5 controller must be series C, firmware revision N.1 or later; series D, firmware revision E.1 or later; or series E, firmware revision D.1 or later.

<sup>(4)</sup> The 1785-ENET Ethernet communication interface module must be series A, firmware revision D or later.

<sup>(5)</sup> The PLC-5, SLC, and MicroLogix processors appear as I/O points to the Logix controller. Use the appropriate DeviceNet interface for the controller.

<sup>(6)</sup> Use a 1747-L55x controller with OS501 or later.

## Communicate with Other Communication Devices

The controller can communicate with these communication devices.

Communication Device	EtherNet/IP Network <sup>(1)</sup>	ControlNet Network	DeviceNet Network <sup>(2)</sup>
Linking device (ControlLogix controllers only)	1788-EN2DN	1788-CN2DN 1788-CN2FF	1788-EN2DN <sup>(3)</sup> 1788-CN2DN
PCMCIA card	—	1784-PCC	1784-PCD
PCI card	—	1784-PCIC 1784-PCICS	1784-PCID 1784-PCIDS 1784-CPCIDS
Drives SCANport module	—	1203-FM1 1203-FB1 <sup>(4)</sup>	—
Communication module	—	1203-CN <sup>(5)</sup> 1770-KFC15 1770-KFCD15 1747-KFC15	1770-KFD 1770-KFG
Communication card	—	1784-PKTCS 1784-KTCS 1784-KTCX15	1784-PKTX 1784-PKTXD
USB communication device	—	1784-U2CN	1784-U2DN

<sup>(1)</sup> A non-EtherNet/IP controller requires a 1761-NET-ENI interface to connect to an EtherNet/IP network. This interface is only a messaging bridge.

<sup>(2)</sup> In the CompactLogix system, use either a 1769-SDN scanner (control I/O and send/receive messages) or a 1761-NET-DNI interface (messaging bridge).

<sup>(3)</sup> The 1788-EN2DN does not support safety communications (CIP Safety).

<sup>(4)</sup> Use a CIP generic MSG instruction to communicate with the 1203-FM1 SCANport module on a DIN rail that is remote to the controller. The remote DIN rail also requires a 1794-ACN15 or 1794-ACNR15 ControlNet adapter module.

<sup>(5)</sup> Use the generic module configuration to configure the 1203-CN1 module and a CIP generic MSG instruction to communicate with the module.

## Controller Connections

A CompactLogix system uses connections to establish communication links between devices. The types of connections include:

- controller-to-local I/O modules or local communication modules.
- controller-to-remote I/O or remote communication modules.
- controller-to-remote I/O (rack-optimized) modules.
- produced and consumed tags.
- messages.
- controller access by RSLogix 5000 programming software.
- controller access by RSLinx software for HMI or other applications.

You indirectly determine the number of connections the controller uses by configuring the controller to communicate with other devices in the system. The limit of connections may ultimately reside in the communication module you use for the connection. If a message path routes through a communication module, the connection related to the message also counts towards the connection limit of that communication module.

### 1769-L23x CompactLogix Connections

The controller you select determines the connections for I/O and messages.

Controller	Supports
1769-L23EQB1B	32 CIP connections
1769-L23EQBFC1B	8 TCP/IP connections

The total connection requirements for a 1769 CompactLogix system include both local and remote (distributed) connections. The controller supports 100 connections. The available remote connections depend on the network interface.



### 1769-L3x CompactLogix Connections

The controller you select determines the connections for I/O and messages.

Controller	Supports
1769-L32C 1769-L35CR	32 CIP connections
1769-L32E 1769-L35E	32 CIP connections 32 TCP/IP connections

The total connection requirements for a 1769 CompactLogix system include both local and remote (distributed) connections. The controller supports 100 connections. The available remote connections depend on the network interface.

### 1768-L4x CompactLogix Connections

The communication module you select determines the connections for I/O and messages.

Communication Module	Supports
1768-ENBT 1768-EWEB	128 CIP connections 64 TCP/IP connections
1768-CNB 1768-CNBR	48 CIP connections

The total connection requirements for a 1768 CompactLogix system include both local and remote (distributed) connections. The controller supports 250 connections. The available remote connections depend on the network interface.

## Determine Total Connection Use

The total connection requirements for a CompactLogix system include both local and remote (distributed) connections. The 1769-L23x and 1769-L3x controllers support 100 connections; the 1768-L4x controllers supports 250 connections. The available remote connections depends on the network interface.

Connection Type	Device Quantity	Connections per Device	Total Connections
Remote ControlNet communication module Configured as a direct (none) connection Configured as a rack-optimized connection		0 or 1	
Remote I/O module over a ControlNet network (direct connection)		1	
Remote Ethernet communication module Configured as a direct (none) connection Configured as a rack-optimized connection		0 or 1	
Remote I/O module over an EtherNet/IP network (direct connection)		1	
Remote device over a DeviceNet network (accounted for in rack-optimized connection for local 1756-DNB module)		0	
Produced tag and first consumer		2	
Each additional consumer		1	
Consumed tag		1	
Cached message		1	
Message		1	
RSLinx Enterprise subscriber (16 maximum)		1	
<b>Total</b>			

## CompactLogix Controller Accessories

### 1784 Industrial CompactFlash Cards

CompactFlash cards offer nonvolatile memory (flash) to permanently store a user program and tag data on a controller. You install the CompactFlash card in a socket on the controller. You can manually trigger the controller to save to or load from nonvolatile memory or configure the controller to load from nonvolatile memory on powerup.

#### Environmental Specifications - 1784-CF64, 1784-CF128

Attribute	1784-CF64, 1784-CF128
Temperature, operating IEC 60068-2-1 (Test Ad, Operating Cold), IEC 60068-2-2 (Test Bd, Operating Dry Heat), IEC 60068-2-14 (Test Nb, Operating Thermal Shock)	-25...70 °C (-13...158 °F)
Temperature, storage IEC 60068-2-1 (Test Ab, Unpackaged Nonoperating Cold), IEC 60068-2-2 (Test Bb, Unpackaged Nonoperating Dry Heat), IEC 60068-2-14 (Test Na, Unpackaged Nonoperating Thermal Shock)	-40...85 °C (-40...185 °F)
Relative humidity IEC 60068-2-30 (Test Db, Unpackaged Nonoperating Damp Heat)	5...95% noncondensing
Vibration IEC 60068-2-6 (Test Fc, Operating)	2 g @ 10...500 Hz
Shock, operating IEC 60068-2-27 (Test Ea, Unpackaged Shock)	30 g
Shock, nonoperating IEC 60068-2-27 (Test Ea, Unpackaged Shock)	50 g

#### Technical Specifications - 1784-CF64, 1784-CF128

Attribute	1784-CF64	1784-CF128
Memory	64 MB	128 MB
Weight, approx.	14.2 g (0.5 oz)	

#### Certifications - 1784-CF64, 1784-CF128

Certification <sup>(1)</sup>	1784-CF64, 1784-CF128
CE	European Union 2004/108/EC EMC Directive, compliant with: <ul style="list-style-type: none"> <li>EN 61000-6-4; Industrial Emissions</li> <li>EN 61326-1; Meas./Control/Lab., Industrial Requirements</li> <li>EN 61000-6-2; Industrial Immunity</li> <li>EN 61131-2; Programmable Controllers (Clause 8, Zone A &amp; B)</li> </ul>
C-Tick	Australian Radiocommunications Act, compliant with: AS/NZS CISPR 11; Industrial Emissions

<sup>(1)</sup> When marked. See the Product Certification link at <http://www.ab.com> for Declarations of Conformity, Certificates, and other certification details.

## 1769 CompactLogix Batteries

The 1769-L23x and 1769-L3x controllers come with one 1769-BA lithium battery. The 1768 controller does not require a battery. The controller uses internal flash memory to store its program during shutdown. Energy stored in the 1768 power supply maintains controller power long enough to store the program to internal flash memory (not the external CompactFlash card).

### Technical Specifications - 1769-BA

Attribute	1769-BA
Description	Lithium battery (0.59 g)
CompactLogix controllers	1769-L23-QBFC1B, 1769-L23E-QB1B, 1769-L23E-QBFC1B  1769-L31  1769-L32C, 1769-L35CR  1769-L32E, 1769-L35E

## Serial Communication Cables

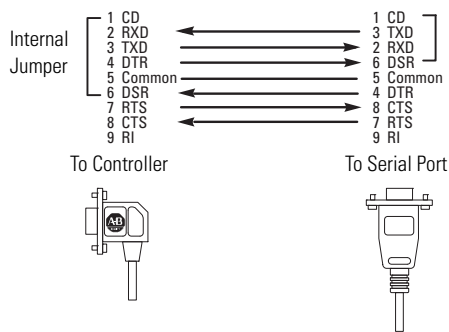

Attribute	1756-CP3	1747-CP3
Connector type	Female 9-pin D-shell	
Connector angle	Right angle connector to controller, straight to serial port	
Length	3 m (118 in.)	



# Rockwell Automation Support

Rockwell Automation provides technical information on the Web to assist you in using its products. At <http://www.rockwellautomation.com/support/>, you can find technical manuals, a knowledge base of FAQs, technical and application notes, sample code and links to software service packs, and a MySupport feature that you can customize to make the best use of these tools.

For an additional level of technical phone support for installation, configuration, and troubleshooting, we offer TechConnect support programs. For more information, contact your local distributor or Rockwell Automation representative, or visit <http://www.rockwellautomation.com/support/>.

## Installation Assistance

If you experience an anomaly within the first 24 hours of installation, review the information that is contained in this manual. You can contact Customer Support for initial help in getting your product up and running.

United States or Canada	1.440.646.3434
Outside United States or Canada	Use the <a href="#">Worldwide Locator</a> at <a href="http://www.rockwellautomation.com/support/americas/phone_en.html">http://www.rockwellautomation.com/support/americas/phone_en.html</a> , or contact your local Rockwell Automation representative.

## New Product Satisfaction Return

Rockwell Automation tests all of its products to ensure that they are fully operational when shipped from the manufacturing facility. However, if your product is not functioning and needs to be returned, follow these procedures.

United States	Contact your distributor. You must provide a Customer Support case number (call the phone number above to obtain one) to your distributor to complete the return process.
Outside United States	Please contact your local Rockwell Automation representative for the return procedure.

## Documentation Feedback

Your comments will help us serve your documentation needs better. If you have any suggestions on how to improve this document, complete this form, publication [RA-DU002](#), available at <http://www.rockwellautomation.com/literature/>.

## [www.rockwellautomation.com](http://www.rockwellautomation.com)

---

### Power, Control and Information Solutions Headquarters

Americas: Rockwell Automation, 1201 South Second Street, Milwaukee, WI 53204 USA, Tel: (1) 414.382.2000, Fax: (1) 414.382.4444

Europe/Middle East/Africa: Rockwell Automation, Vorstlaan/Boulevard du Souverain 36, 1170 Brussels, Belgium, Tel: (32) 2 663 0600, Fax: (32) 2 663 0640

Asia Pacific: Rockwell Automation, Level 14, Core F, Cyberport 3, 100 Cyberport Road, Hong Kong, Tel: (852) 2887 4788, Fax: (852) 2508 1846